

Hotel Service

Optimised day-to-day hotel processes



wanzl

INNOVATION
MADE BY WANZL

CREATIVE CENTER
wanzl

Contents

A SUCCESS STORY	5	02 FRONT OFFICE	44
HIGHLIGHTS_MADE BY WANZL	7	Luggage collection trolleys	46
OVERVIEW	8-9	⁰¹ Premium GS-Trend	46
01 HOUSEKEEPING	10	⁰² GS-Lobby	48
Chambermaid trolleys	13	⁰³ GS-Lobby XS	49
Dimensions	13	⁰⁴ GS-Group	50
⁰¹ Premium ZP Classic	14	⁰⁵ GS-Compact	51
⁰² Premium ZP Eco	16	Luggage transport trolleys	52
⁰³ Premium ZP Clean	18	⁰⁶ Aera 300 L	52
⁰⁴ Premium ZP Basic	20	⁰⁷ Voyager 3000	53
Order part	22	⁰⁸ Travel 300	54
Accessories	23	Guidance systems	55
⁰⁵ ZP Unique	24	⁰⁹ Part Flex 2000	55
Invisible housekeeping	26	¹⁰ Part Line 2000	56
⁰⁶ hotel-max. L and hotel-max. S	26	03 FOOD + BEVERAGES	58
⁰⁷ Premium ZP-5	28	Minibar filling trolleys	60
Handcarts	30	⁰¹ Premium MBW Smart	60
⁰⁸ SW 80	30	⁰² Premium MBW Secure	62
⁰⁹ SW 145 KX	32	Service and serving trolleys	64
¹⁰ SW 240	33	⁰³ Terrace trolley ZP Unique	64
Mobile containers and transport baskets	34	⁰⁴ Room-service table RSVC-Comfort	65
¹¹ AL sprung-base trolley	34	⁰⁵ Serving trolleys EG 300 · EU 300	66
¹² AL shelved laundry container	35	Bottle trolley	67
¹³ RC/S1	36	⁰⁶ FW-8 · FW-16	67
¹⁴ RC/S8	37	⁰⁷ TBL 16	68
¹⁵ RC/N1	38	⁰⁸ TBL 20	69
¹⁶ RC/N2	39	04 STORAGE + SHELVING	70
¹⁷ TK-R and TK-D	40	Service shelves	72
Room-change trolleys, coat rail and luggage stand	41	⁰¹ High rack	72
¹⁸ Room-change trolleys RCW/RCW S	41	High rack order part	73
¹⁹ Coat rail GR	42	⁰² Table linen trolley	74
²⁰ Luggage stand KS 600	43	Transport trolleys	75
		⁰³ Mattress trolley	75
		⁰⁴ T25	76
		⁰⁵ SP2	77



Wanzl Hotel Service

Continuing a long success story



PLATE TROLLEY 1976



TRAY TROLLEY 1984



ZP CLASSIC CHAMBERMAID TROLLEY 2012

■ **At Wanzl, we know** what people will want tomorrow. As a world market leader for shopping trolleys, we provide the right answers for Hotel Service too. As early as the 1970s, the first Hotel Service products were already being produced, such as the plate and tray trolleys for optimised day-to-day processes in the hotel and catering trade.

■ **Today, Wanzl employs** over 4,000 employees at eleven production sites worldwide, working on new business areas and products and on unusual product designs based on consistently high quality and a vast production range. The aim: perfectly satisfied customers.

***The world is changing.
Take advantage of it!***

■ **For optimised day-to-day hotel processes.** Wanzl's professional competence ensures effective work processes in the hotel and catering trade – and thus also the competitiveness and business success of its partners. Functional, economical and userfriendly products minimise personnel requirements and help to satisfy the high expectations and requirements of your guests.



Highlights_MADE BY WANZL

Innovative products from a single source



IN-HOUSE CASTOR PRODUCTION



IN-HOUSE CAD DEVELOPMENT

Production

■ **Wanzl sets the standards for production:** In all production processes, Wanzl's quality policy results in products with the best materials, first-class workmanship and well-finished surfaces. This ensures long-term maintenance-free use and investment security.

Quality

■ **Wanzl sets the standards for quality:** particularly with regard to smooth rolling: the castors are mounted on 2 maintenance-free ball bearings, have abrasion-proof treads and feature steering forks with ball bearings. As a result, our chambermaid trolleys are quiet, smooth-running and easy to steer.

Innovation

■ **Wanzl sets the standards for innovation:** from practical experience – for practical use: using cutting-edge production and design technology, we create innovative, forward-looking products and constantly set new standards for handling and effectiveness. This allows us to streamline your processes, guaranteeing you have the best possible facilities in future too.



01 Housekeeping

02 Front Office

03 Food + Beverages

04 Storage + Shelving



01 Product overview

01.01 – 01.05 Chambermaid trolleys



01 ZP CLASSIC



02 ZP ECO



03 ZP CLEAN



04 ZP BASIC



05 ZP UNIQUE

01.06 – 01.07 Invisible housekeeping



06 HOTEL-MAX. L + HOTEL-MAX. S



07 ZP-5

01.08 – 01.10 Handcarts



08 SW 80



09 SW 145 KX



10 SW 240

01.11 – 01.17 Mobile containers and transport baskets

11 AL SPRUNG
BASE TROLLEY12 AL SHELVED
LAUNDRY CONTAINER

13 RC/S1



14 RC/S8



15 RC/N1



16 RC/N2



17 TK-R + TK-D

01.18 – 01.20 Room-change trolleys, coat rail and luggage stand



18 RCW + RCW S



19 GR



20 KS 600

01 Housekeeping





01.01 – 01.04 Overview – Dimensions

ZP-7 Premium ZP Classic Premium ZP Eco Premium ZP Clean

Dimensions (mm): Castors \varnothing 200
Loading capacity:
Trolley shelves max. 50 kg each
Trolley side parts max. 20 kg each

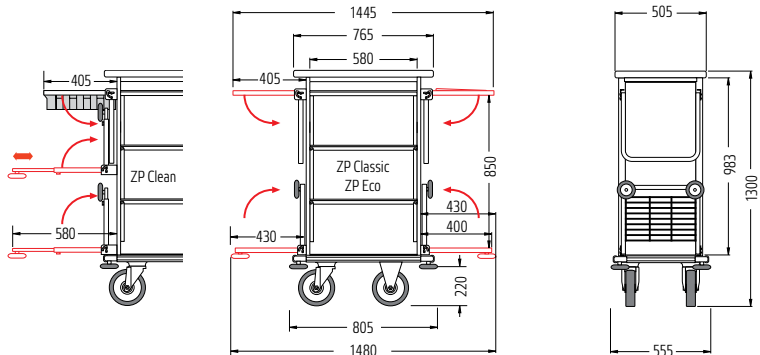

ZP-9 Premium ZP Classic Premium ZP Eco Premium ZP Clean

Dimensions (mm): Castors \varnothing 200,
5th castor \varnothing 160
Loading capacity:
Trolley shelves max. 50 kg each
Trolley side parts max. 20 kg each

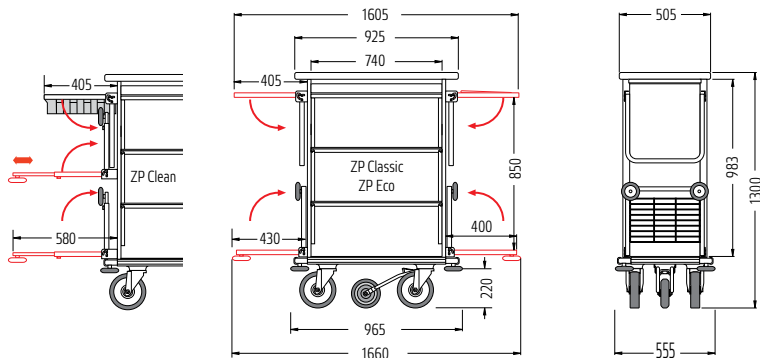

ZP-11 Premium ZP Classic Premium ZP Eco Premium ZP Clean

Dimensions (mm): Castors \varnothing 200,
5th castor \varnothing 160
Loading capacity:
Trolley shelves max. 50 kg each
Trolley side parts max. 20 kg each

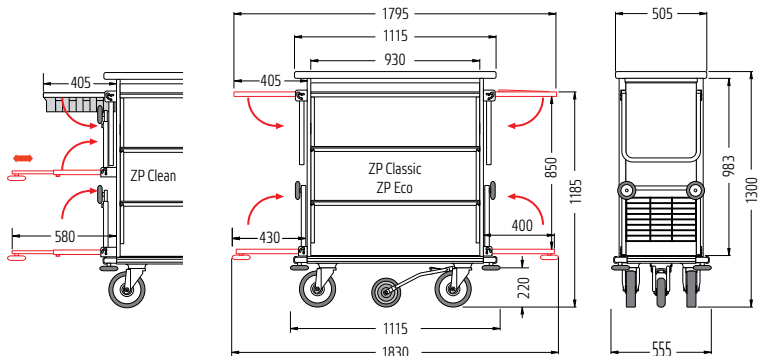

ZP-9 Premium ZP Basic

Dimensions (mm): Castors \varnothing 125
Loading capacity:
Trolley shelves max. 50 kg each
Trolley side parts max. 20 kg each

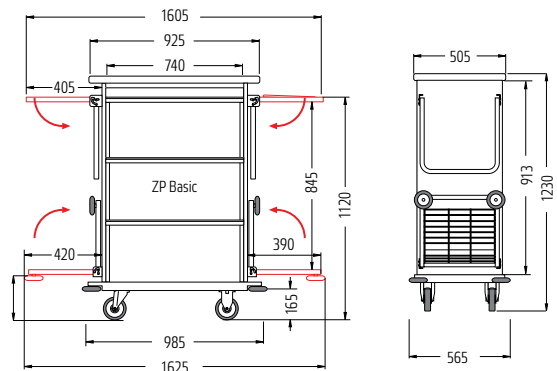

01.01 Premium ZP Classic

Perfect housekeeping

- > Agile and easy to manoeuvre thanks to the 5th castor
- > With all-round bumper profile and integrated deflectors to protect your furniture and equipment
- > Adaptable: available in 3 sizes and 3 finishes



Design pend.

Finishes



ZP-7 CLASSIC

Anthracite finish

Illustration shows optional equipment

01.01 Premium ZP Classic

■ **The tried-and-tested design from Wanzl.** The special features of the Premium Classic chambermaid trolley help the room service personnel to provide a perfect service. It can be customised as required by adding practical accessories.

Standard equipment: Steel-tube design, fold-out bars for hanging laundry and rubbish bags, one of which is a bar with folding lid for closing 120-litre plastic bags. Lower bars, each with grate. 2 fixed and 2 height-adjustable shelves in matching finish.

Finish: Plastic powder coating in titanium grey.

ZP-7 model: 2 swivel castors, 2 fixed castors, with polyamide tread.

ZP-9 and ZP-11 models: 4 swivel castors with polyamide tread, 5th castor in the centre with rubber tread.



ZP-7 CLASSIC
Anthracite finish

Design pend.

5th castor – extremely manoeuvrable

Simply perfect: The 5th castor allows the trolley to turn on the spot. Available for the ZP-9 and ZP-11 models.



All-round protection for your hotel interior

Protective feature: Integrated deflector profile and rubber deflectors protect the hotel interior.



Accessories: Polyester cover for rubbish bag

Visually and functionally perfect: "Invisible" rubbish bag thanks to polyester cover. A much more pleasing look.



01.02 Premium ZP Eco

Housekeeping meets environmental protection

- > *Simple waste separation*
- > *2 waste sorting boxes as standard*
- > *Adaptable: available in 3 sizes and 3 finishes*



Design pend.

Finishes



ZP-11 ECO
Wenge finish
Illustration shows optional equipment

01.02 Premium ZP Eco

■ **The environmentally friendly design from Wanzl.** The special features of the Premium Eco chambermaid trolley are particularly helpful for separating waste. It too can be upgraded with practical accessories.

Standard equipment: Steel-tube design, fold-out bars for hanging laundry and rubbish bags, one of which is a bar with folding lid for closing 50-litre plastic bags. Lower bars, each with grate. 2 stackable waste separation boxes with lid. 2 fixed and 2 height-adjustable shelves in matching finish.

Finish: Plastic powder coating in titanium grey.

ZP-7 model: 2 swivel castors, 2 fixed castors, with polyamide tread.

ZP-9 and ZP-11 models: 4 swivel castors with polyamide tread, 5th castor in the centre with rubber tread.



ZP-11 ECO
Wenge finish

Design pend.

Practical clamp fastening

Convenient detail

Clamp fastening ensures the rubbish bag is held securely.



Waste sorting boxes as standard

Simple waste separation

2 standard boxes allow different recyclable materials to be separated easily.



Adjustable shelf

Inserted without tools:

The shelf can be easily set at the desired height.



Ash box accessory

Prevents odours The lid also prevents odours escaping when providing room service.



01.03 Premium ZP Clean

Ultra-hygienic housekeeping

- > *Cleaning made easy*
- > *Retaining net for holding a cleaning tray*
- > *Extendible trays for customised storage space*



ZP-9 CLEAN
Oak finish
Illustration shows optional equipment

Finishes



01.03 Premium ZP Clean

■ **The clean design from Wanzl.** The special features of the Premium Clean chambermaid trolley help make cleaning more efficient. Like all Premium models, it can be upgraded with practical accessories.

Standard equipment: Steel-tube design. 2 fixed and 2 height-adjustable shelves in matching finish. Right-hand side: fold-out bar for hanging a rubbish bag. Lower loop with wire mesh and 2 stackable waste sorting boxes with lids.

Left-hand side: adaptable equipment with extendible, pull-out shelves and a retaining net for cleaning materials.

Finish: Plastic powder coating in titanium grey.

ZP-7 model: 2 swivel castors, 2 fixed castors, with polyamide tread.

ZP-9 and ZP-11 models: 4 swivel castors with polyamide tread, 5th castor in the centre with rubber tread.



ZP-9 CLEAN

Oak finish

Illustration shows optional equipment

Shelves and wire mesh

Equipment options

Top

- Net for cleaning materials, folding

Middle options

- Extendible, fold-out shelf with locking pegs or
- Fold-out grate or
- Net for cleaning materials, folding

Bottom options

- Extendible, fold-out shelf
- Fold-out grate

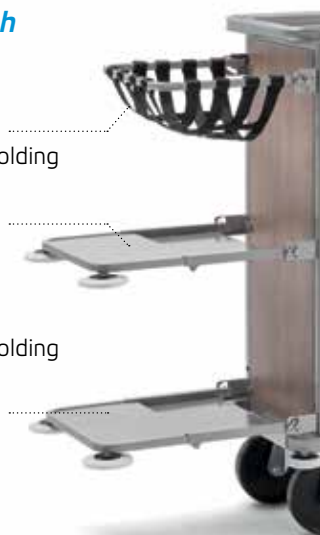

Utensil bag accessory

In polyester

As practical as it gets.

For items that always need to be in the same place, ready to hand.

Whether it's guest supplies or cleaning materials, whatever you need.



01.04 Premium ZP Basic

Housekeeping – extra economical

- > *Practical basic features*
- > *With all-round bumper profile and integrated deflectors to protect your furniture and equipment*
- > *Platinum white finish*



ZP-9 BASIC
Platinum white finish
Illustration shows optional equipment

01.04 Premium ZP Basic

■ **The cost-saving design from Wanzl.** The practical features of the Premium Basic chambermaid trolley offer the usual Wanzl quality, even for tighter budgets.



ZP-9 BASIC

Platinum white finish

Illustration shows optional equipment

Standard equipment: Steel-tube design, fold-out bars for hanging laundry and rubbish bags, one of which is a bar with folding lid for closing 120-litre plastic bags. Lower bars, each with mesh. 3 fixed shelves, platinum white finish.

Finish: Plastic powder coating in titanium grey.

Castors: 2 swivel castors, 2 fixed castors with polyamide tread, castors ø 125 mm.

Deflectors

Effective protection

Deflectors protect the interior decor from damage.



Fold-out side parts

Provide flexibility
in confined spaces.
A practical solution to
save space.



ZP Premium Basic

Platinum white finish

Order no.

04.01240.95-0000

01.01 – 01.04 Order part

Classic, Eco, and Clean chambermaid trolleys



ANTHRACITE FINISH



OAK FINISH



WENGE FINISH

Models		ZP-7	ZP-9	ZP-11
Dimensions		765 x 527 x 1300	925 x 527 x 1300	1115 x 527 x 1300
		Order no.	Order no.	Order no.
ZP Premium Classic	Anthracite, oak, wenge finish	04.01244.95-V	04.01245.95-V	04.01246.95-V
ZP Premium Eco	Anthracite, oak, wenge finish	04.01247.95-V	04.01248.95-V	04.01249.95-V
ZP Premium Clean	Anthracite, oak, wenge finish	04.01257.95-V	04.01258.95-V	04.01259.95-V

Optional equipment				
Closable lid	Anthracite, oak, wenge finish	☑	☑	☑
Additional shelves	Anthracite, oak, wenge finish	☑	☑	☑
Drawer, plastic powder coating in titanium grey		☑	☑	☑
Drawer compartment divider		☑	☑	☑
Lockable plastic roller shutter, in silver		☑	☑	☑
Bag holder, extended, incl. 2 polyester bags		☑	☑	☑
Double rubbish bag holder, plastic powder coating in titanium grey		☑	☑	☑
Castors with rubber tread (1 set)		☑	☑	☑
For chambermaid trolleys with roll-down panel				
Additional shelves, shortened	Anthracite, oak, wenge finish	☑	☑	☑
Accessories				
Wooden box for small items, painted pearl light grey		00.21837.78-9022	00.21837.78-9022	00.21837.78-9022
Wooden box for small items, clear varnished		00.60694.78-0000	00.60694.78-0000	00.60694.78-0000
Top box, metal, plastic powder coating in titanium grey		04.03504.73-7084	04.03504.73-7084	04.03504.73-7084
Spaces for top box on top shelf		1	1	2
Waste sorting box, silver-grey plastic		04.06555.07-0000	04.06555.07-0000	04.06555.07-0000
Lid for waste sorting box, silver-grey plastic		04.06668.07-0000	04.06668.07-0000	04.06668.07-0000
Ash box, metal, plastic powder coating in titanium grey		00.22176.73-7084	00.22176.73-7084	00.22176.73-7084
Brochure holder, metal, plastic powder coating in titanium grey		00.22289.73-7084	00.22289.73-7084	00.22289.73-7084
Bags for repeat order		Order no.	Order no.	Order no.
Utensils pocket, polyester, grey		00.22515.00-0000	00.22515.00-0000	00.22515.00-0000
Polyester bag, grey, 110 litres, 1 unit		00.22402.00-0000	00.22402.00-0000	00.22402.00-0000
Polyester bag, beige, 110 litres, 1 unit		00.36979.00-0000	00.36979.00-0000	00.36979.00-0000
Plastic bag, grey, 50 litres, 1 pack containing 15 units		00.22741.00-0000	00.22741.00-0000	00.22741.00-0000
Plastic bag, blue, 50 litres, 1 pack containing 15 units		00.23080.00-0000	00.23080.00-0000	00.23080.00-0000
Plastic bag, grey, 120 litres, 1 pack containing 25 units		00.24436.00-0000	00.24436.00-0000	00.24436.00-0000

01.01 – 01.04 Overview

Optional equipment

1 CLOSABLE LID

2 LOCKABLE ROLL-DOWN PANEL

Better safe than sorry.

3 ADDITIONAL DRAWER

4 ADDITIONAL SHELF

Lots of space for the utensils required.

5 RUBBER CASTOR

Extremely quiet when moving, the perfect castors for stone floors.

6 DOUBLE RUBBISH BAG HOLDER

Waste separation made truly easy when providing room service.

7 FLEXIBLE MOP HOLDER

For storing bulky cleaning utensils securely.



Accessories

8 TOP BOX

For transporting high-value goods securely.

9 UTENSIL BAG

Accessory for even more space to accommodate more utensils.

10 POLYESTER COVER

Visually and functionally perfect to keep the rubbish bag hidden.

11 BOX FOR SMALL ITEMS

Even more organisation space for extra utensils.

12 ASH BOX

Odours are eliminated.

13 BROCHURE HOLDER

Ready to hand for presenting your image with brochures.

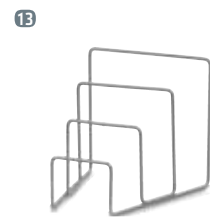

01.05 Premium ZP Unique

The versatile quick-change artist

- > Suitable for indoor and outdoor use
- > Low weight thanks to washable fabric cover
- > Large volumes, large load capacity



ZP UNIQUE
CHAMBERMAID TROLLEY



Lightweight and easy to manoeuvre

The hard-wearing fabric cover is stretched over the uprights of the frame, which holds 3 robust shelves and a deep plastic tray for guest supplies.

The Premium ZP Unique is a compact, lightweight trolley which has a large volume and load capacity and

is also highly stable. This versatile model is impressively easy to steer and manoeuvre.

Premium ZP Unique chambermaid trolley

■ Comes with a cover suitable for indoor and outdoor use made from a hard-wearing, softshell fabric that can be printed to meet individual requirements. Innovative, flexible and practical, designed for everyday use. The Premium ZP Unique takes up very little space when stored.



1 ROLL-DOWN PANEL (OPTIONAL)
Perfect for transporting your housekeeping equipment discreetly.

2 BRANDING (OPTIONAL)
Your hotel logo according to your requirements and to ensure a consistent corporate design.

3 REMOVABLE BAG HOLDERS
The bag holders can be removed quickly and easily without using tools.

ZP UNIQUE CHAMBERMAID TROLLEY

Standard equipment: Solid steel structure, 3 robust metal shelves, 1 deep plastic tray. 2 fold-out bars to hold laundry and rubbish bags, one of which has a folding lid and a clamp for 120-litre plastic bags. Hard-wearing textile cover.

Finish: Plastic powder coating in titanium grey.

Castors: 2 swivel castors, 2 fixed castors, rubber tread, castor Ø 125 mm.

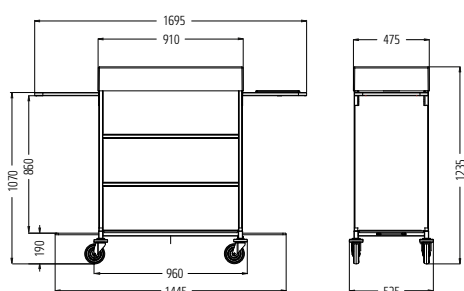

ZP Unique	Order no.
Standard equipment 1695 x 525 x 1235 mm	04.07480.95-V
Load capacity: Shelves max. kg each	50
Load capacity: Side parts max. kg each	20
Accessories	Order no.
Roll-down panel in textile fabric, silver-grey	77.18291.95-0001
Branding (logo print)	On request

01.06 hotel-max

For invisible housekeeping

> "Invisible" assistants for disturbance-free housekeeping

> For hotels with an upmarket ambience

> Compact, manoeuvrable and stylish



HOTEL-MAX. L
service trolley with service
basket

Pat. pend.



HOTEL-MAX. S
service trolley with
service basket

Pat. pend.

Standard equipment

hotel-max. S and hotel-max. L service trolleys:

The chassis consists of a round tube design with plastic powder coating. There is a wire storage basket and the wire bottom tray holds the service basket; hotel-max. L features particularly generous dimensions.

Castors: Made of plastic with wear-resistant tread.

hotel-max. S and hotel-max. L service baskets:

Plastic with woven willow look. Food-safe, heat-resistant to 70°C and UV stable. Washable and suitable for machine washing.

Extras on the hotel-max. L service basket:

There are 2 basket heights, each equipped with a small item basket. Additionally, the shorter version* has compartment dividers.

* Height 440 mm

hotel-max. S and hotel-max. L

■ **Elegant and manoeuvrable multi-function transporters by Wanzl.** The hotel-max. S and the hotel-max. L do their work as a constant, "invisible" companion to the chambermaid and thus prevent impairment of the overall impression given by hotels with an upmarket ambience.

Collapsible to save space

The hotel-max. S and hotel-max. L service trolleys can be folded down to occupy very little space when they are not needed. It really does not get any more practical.

Both very quickly become indispensable.



HOTEL-MAX. L

HOTEL-MAX. S

Lots of space for cleaning requirements

Everything you need for housekeeping can be comfortably accommodated in the wire basket on the control handle of the hotel-max.



Particularly gentle

Plastic profiles ensure additional protection of all surfaces. The double edging wire offers the service basket additional support.

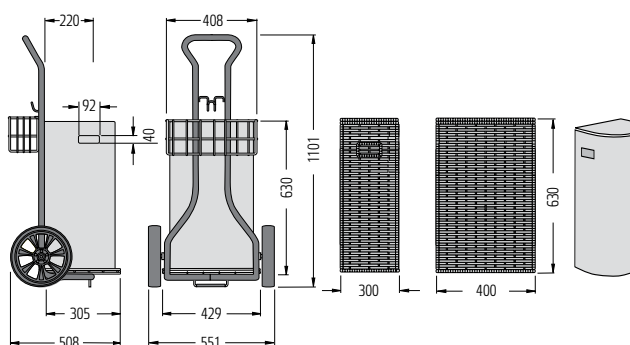
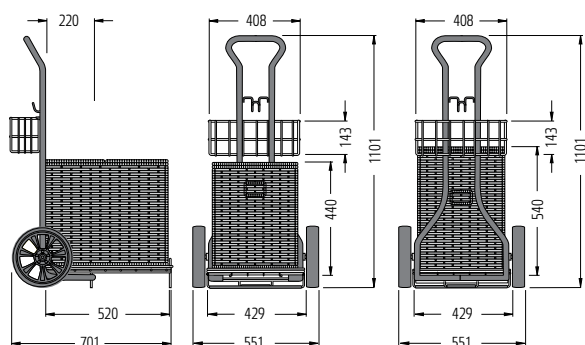

hotel-max. L		Order no.
hotel-max. service trolley* W 551 x D 701 x H 1101 mm		04.73112.96-0001
Service basket for hotel-max. with small item basket and compartment dividers W 390 x D 520 x H 440 mm	Beige	05.47348.07-0000
	Black	05.47348.07-0001
Service basket for hotel-max. with small item basket, without compartment dividers W 390 x D 520 x H 540 mm	Beige	05.53563.07-0000
	Black	05.53563.07-9005

hotel-max. S		Order no.
hotel-max. service trolley* W 551 x D 508 x H 1101 mm		04.72999.96-0001
Service basket for hotel-max. W 400 x D 300 x H 630 mm	Black	05.53676.07-9005

* Pat. pend.

01.07 Premium ZP-5

A true all-rounder

- > *Functionality and style*
- > *Excellent manoeuvrability*
- > *Doors retractable into side panels*



ZP-5
Anthracite finish
Illustration shows optional equipment

Design pend.
Pat. pend.



OUR RECOMMENDATION:
For effective housekeeping in combination
with the **SW 145 KX** (see page 32)



ZP-5
White finish
Illustration shows optional equipment

Finishes



01.07 Premium ZP-5

■ **Whether it is used in events venues** for building and utilities management or for seamless room service, the Premium ZP-5 chambermaid trolley blends functionality and style.

ZP-5 Effective protection

Deflectors and bumper rails protect the interior decor from damage.



ZP-5 With pushing handle

Easy, convenient handling in tight spaces thanks to optional pushing handle.



ZP-5 With robust railing

For safe manoeuvring and to create extra storage space.



ZP-5 With 2nd drawer

A 2nd drawer is available as an option for the ZP-5 in addition to the standard equipment.



ZP-5 with adjustable shelf

Adjustable to any height to optimise the space needed for laundry or guest supplies.

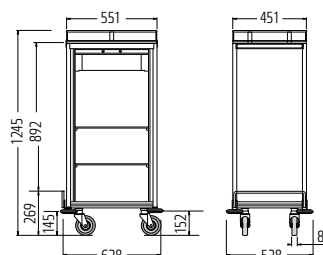

Dimensions in mm
Castors ø 125 mm

Standard equipment ZP-5:

Stylish steel tube construction with retractable side-ways doors. Chassis with all-round bumper profile and 4 plastic deflectors.

1 pull-out drawer with damped retraction, 2 height-adjustable shelves, top storage area features all-round rail.

Finish: Plastic powder-coating in titanium grey.

Castors: 4 swivel castors with rubber tread, alternatively 2 fixed and 2 swivel castors.

ZP-5		Order no.
Standard equipment	628 x 528 x 1245 mm	04.06250.95-V001
Equipped with 2nd drawer		04.06250.95-V002
Accessories		Order no.
Additional shelf with fixings		77.22726.95-0000
Handle, left or right.		77.25322.73-7084
Utensil bag holder		77.25548.73-7084
Utensil bag		00.22515.00-0000
Wooden box for small items, painted pearl light grey		00.21837.78-9022
Brochure holder		00.22289.73-7084

01.08 Handcart SW 80

Sorting laundry made easy

- > 1 – 3 modules with bags in 4 different colours
- > Error-free pre-sorting
- > Robust rubber rings for securing bags

180 kg ↓



SW 3/80

Fabric bags in blue, red and apricot

01.08 Handcart SW 80

■ **Laundry pre-sorting** in the versions with 2 or 3 modules thanks to different coloured bags. These nifty trolleys make sure that all laundry is correctly sorted for washing.

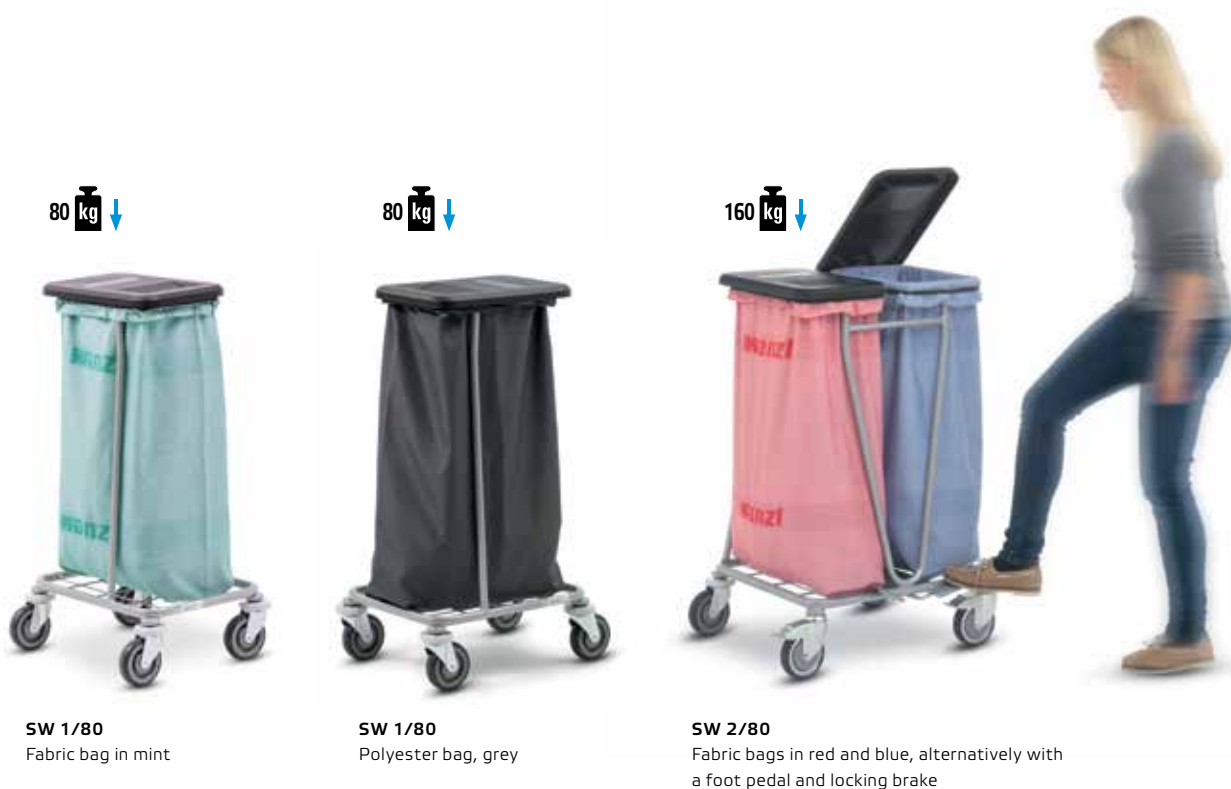

Securely fastened

Robust rubber rings provide simple and secure fastening of the bags.

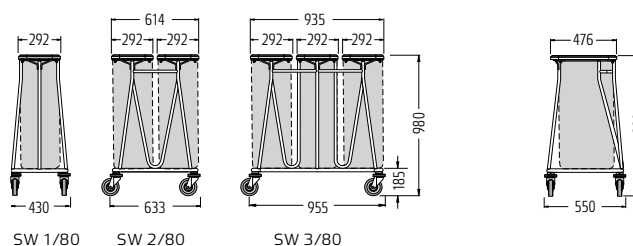

Standard equipment: Sturdy steel-tube design. Chassis with welded grate as support for enhanced stability. Plastic lid with handy opening grip. Bag secured with flexible rubber rings to prevent slipping.

Finish: Plastic powder coating in titanium grey.

Castors: 4 swivel castors with plastic deflector rings, rubber tread.

Handcart SW 80	Order no.
SW 1/80 for hanging 1 bag (bag not included)	04.08928.75-7084
SW 2/80 for hanging 2 bags (bags not included)	04.09041.75-7084
SW 3/80 for hanging 3 bags (bags not included)	04.09154.75-7084
Accessories (bags for initial and repeat orders)	
1 fabric bag, 80 litres, red	00.70540.00-0000
1 fabric bag, 80 litres, blue	00.60935.00-0000
1 fabric bag, 80 litres, apricot	00.61613.00-0000
1 fabric bag, 80 litres, mint	00.59692.00-0000
1 polyester bag, 80 litres, grey	77.69618.00-0000

01.09 Handcart SW 145 KX

The agile model for hotels of every size

- > Smart folding mechanism for space-saving storage
- > Flexible configuration with 2 bag variants
- > Sturdy steel-tube design with grate attached as support surface



SW 145 KX
With polyester bag and hook-and-loop fastener

SW 145 KX
With plastic bag and holder

It couldn't be easier

The non-wearing hook-and-loop fastener secures the polyester bag in position nice and simply.

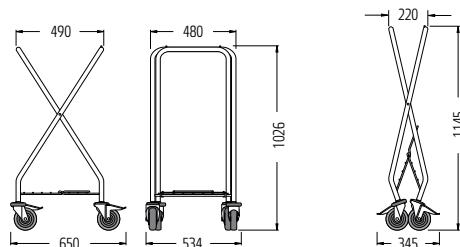

Standard equipment: Sturdy steel-tube design with mesh attached as support surface. Hook-and-loop fastener for polyester bag, flat-steel retainer bar for plastic bag. Slip-proof coating on the top bars.
Finish: Plastic powder coating in titanium grey.
Castors: 4 swivel castors with plastic deflector rings, 2 of which with brake, rubber tread.

Handcart SW 145 KX	Order no.
Basic fixture with polyester bag and hook-and-loop fastener	04.03843.95-7084
Basic fixture with plastic bag and holder	04.03618.95-7084
Accessories	
Holder for plastic bag, incl. fixings	04.03956.52-0000
Bags for repeat order	
1 polyester bag, 145 litres, grey	77.94057.00-0000
1 pack of plastic bags, 120 litres, grey (1 pack = 25 units)	00.24436.00-0000

01.10 Handcart SW 240

XXL model

- > Polyester bag with 240 l volume
- > All-round hook-and-loop fastener for practical securing of the polyester bag
- > Sophisticated steel design with sturdy grate as support surface



Practical hook-and-loop fastener

It couldn't be easier:

The wear-resistant hook-and-loop fastener secures the polyester bag in position.

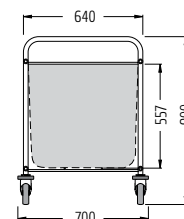
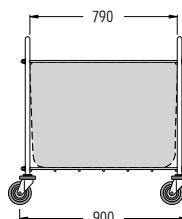

Standard equipment: Steel-tube design with sturdy mesh as support surface. Practical all-round hook-and-loop fastener for securing the large polyester bag, optionally with cover.

Finish: Plastic powder coating in titanium grey.

Castors: 4 swivel castors, with plastic deflector rings and rubber tread.

Handcart SW 240	Order no.
With 1 polyester bag, grey, as standard	04.02374.95-7084
As standard with 1 polyester bag with cover, grey	04.02370.95-7084
Accessories (bags for repeat order)	
Polyester bag, grey, 240 litres	00.58562.00-0000
Polyester bag, grey, 240 litres, with cover	00.58563.00-0000

01.11 AL sprung-base trolley

A laundry trolley for smooth service

- > Robust trolley made of aluminium
- > With automatic height adjustment of the base shelf thanks to a sturdy steel spring
- > Can be used universally



AL SPRUNG-BASE TROLLEY

Perfect position

A sturdy steel spring ensures that the base shelf is always at the ideal height, irrespective of the load.

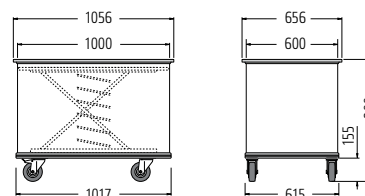

Standard equipment: Robust trolley made of anodised aluminium. The base shelf is raised and lowered automatically depending on the weight of the transported goods. This enables staff to load and unload the trolley comfortably and without straining their back.

Castors: 4 swivel castors, incl. 2 with brake.

AL sprung-base trolley

With adjustable base shelf

Order no.

04.06216.45-0000

01.12 AL shelved laundry container

A mobile container for transporting laundry

- > *Folding container bases enable simple handling*
- > *Plastic bumper profile all-round*
- > *Plastic roll-down panel as standard*



100 kg



Transporting clean linen With roll-down front panel

AL SHELVED LAUNDRY CONTAINER

Mobile container

For transporting dirty laundry and clean linen

in large volumes, saving staff unnecessary trips. The fold-out container shelves can be easily handled, transforming the AL shelved laundry container into a trolley for collecting used laundry in next to no time.

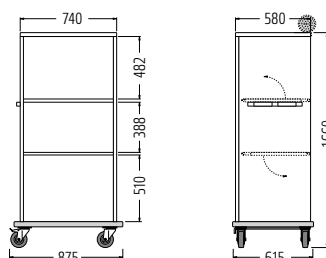

Standard equipment: Sturdy construction made of anodised aluminium. All-round plastic bumper profile. Roll-down front panel made of plastic as standard. Two 90° hinged shelves.

Horizontal position: For clean laundry.

Vertical position: For dirty laundry.

Castors: 4 swivel castors, incl. 2 with brake.

AL shelved laundry container

Incl. roller shutter

Order no.

04.05877.45-0000

01.13 Mobile container RC/S1

With plastic chassis

- > Fully enclosed design
- > Doors with retaining hook for additional fixing
- > Light design with plastic chassis



RC/S1

Basic model with height of 1850 mm including wire shelf (accessories)

Retaining hook

Additional fixing of the door makes unauthorised access more difficult.



Locking

The metal lock bar can also be secured with a padlock, if required.



Safe transport

With sophisticated technology and good handling characteristics, the fully enclosed and theft-proof RC/S1 caters to the multifaceted requirements of the hotel trade.

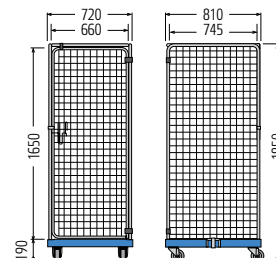

Standard equipment: Chassis made of plastic, with wide supporting rails. Container structure made of round-tube frame with wire mesh, integrated clips. Door with plastic hinges. Opening angle 270°.

Finish: High-gloss, galvanised, chrome-plated.

Castors: 2 fixed and 2 swivel castors made of polyamide.

Mobile container RC/S1	Order no.
Height 1850 mm	06.05537.95-0130
Accessories	
Wire shelf	28.07345.50-0000
Wire shelf, with upward lip on one side	28.09040.50-0000

01.14 Mobile container RC/S8

A mobile transport container

- > Fully enclosed design
- > Doors with lockable bar
- > Optional: adjustable hook-in grate



RC/S8
Mobile container
Illustration shows optional equipment

Locking

The locking mechanism can be secured with a padlock if required.



Wire shelf (optional)

The wire shelf can be attached at an interval of 50 mm. Available in flat variant, or with one side with upward lip.

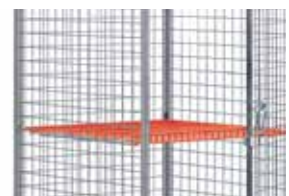

The solution for many different jobs

Ideal for internal transport

High-value goods can also be transported from A to B thanks to the fully enclosed design.

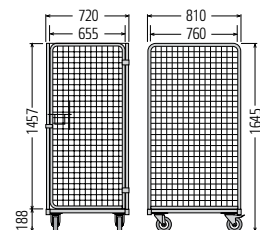

Standard equipment: Metal chassis. Square tube frame with wire support surface, flat steel reinforcing strips. Container structure made of square tube frame with wire mesh, bolted and riveted. Door with metal hinges. Opening angle 270°.

Finish: High-gloss, galvanised, chrome-plated.

Castors: 2 fixed and 2 swivel castors made of polyamide.

Mobile container RC/S8	Order no.
Fully enclosed	06.21639.50-0000
Accessories	
Wire shelf	28.22981.50-0000
Wire shelf, with upward lip on one side	28.22980.50-0000

01.15 Mobile container RC/N1

Light design

- > *Can be nested to save space*
- > *Locking mechanism suitable for padlock*
- > *Hinged support surface*



RC/N1
Basic model with additional wire shelf (accessory)



Can be nested to save space

Space requirement in row

Per mobile container	200 mm
10 mobile containers	2655 mm
50 mobile containers	10,655 mm

Locking

The locking mechanism can be secured with a padlock if required.

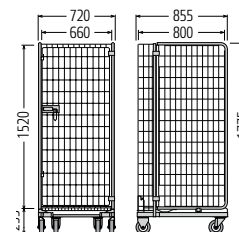

Standard equipment: Square tube frame chassis, welded. Hinged support surface made of wire mesh. Container structure of round tube frame with wire mesh and plastic hinges. Door opening angle 270°.

Finish: High-gloss, galvanised, chrome-plated.

Castors: 2 fixed and 2 swivel castors made of polyamide.

RC/N1 roll cage	Order no.
Nesting	06.16386.50-V001
Accessories	
Wire shelf	00.97494.50-0000

01.16 Mobile container RC/N2

Nesting container variant

- > Effortless collapsing and nesting facilitates storage
- > 2-part door, opened separately
- > With wire shelf and clothes rail as standard

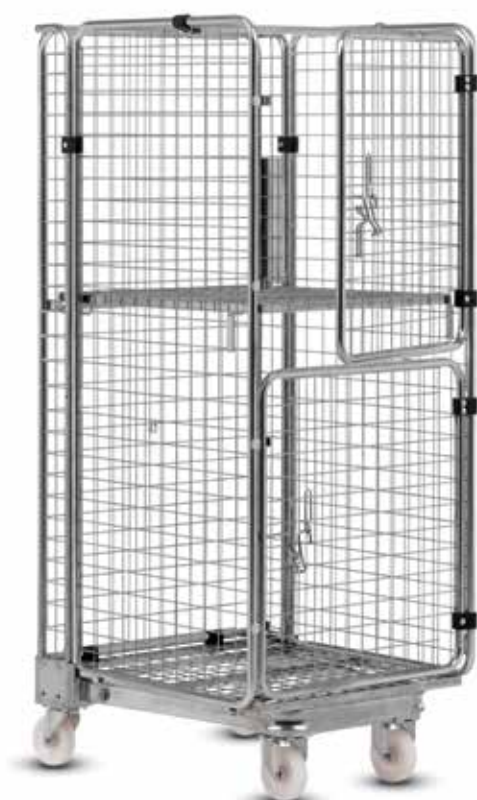

RC/N2
Basic model with hinged wire shelf (standard)



Can be nested to save space

Space requirement in row

Per mobile container	200 mm
10 mobile containers	2.655 mm
50 mobile containers	10.655 mm

Clothes rail

Hinged.
Made of round tube with plastic hinge.



Plate

Made of metal. For stickers, labelling, etc.
Size 114 x 323 mm

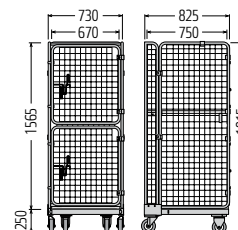
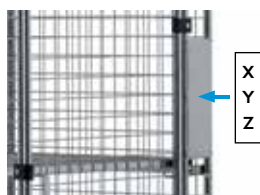

Standard equipment: Square tube frame chassis, curved. Hinged support surface made of square tube frame with wire mesh, reinforced with flat steel strips. Container structure made of round-tube frame with wire mesh and plastic hinges. 2-part door with opening angle 270°.
Finish: High-gloss, galvanised, chrome-plated.
Castors: 2 fixed and 2 swivel castors made of polyamide.

Mobile container RC/N2	Order no.
Nesting, with wire shelf and coat rail as standard	06.17515.50-V001

01.17 Transport baskets TK-R, TK-D

Mobile transport baskets, either open or with a lid

> *Narrow-mesh wire baskets*

> *2 versions*

> *TK-R with bumper, TK-D with lid*



TK-R
Transport basket



TK-D
Transport basket



Both transport baskets can be stacked to save space.

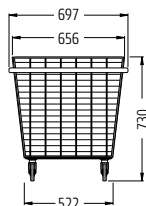
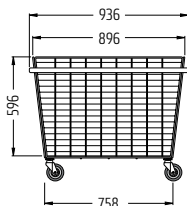

Standard equipment: Narrow-mesh wire basket with white all-round rubber profile as bumper.

Finish: Plastic powder coating, white.

Castors: 4 swivel castors with plastic deflector rings, rubber tread.

Standard equipment: Tall, narrow-mesh wire basket with lid, can be locked if required. Padlock not included.

Finish: High-gloss, galvanised, chrome-plated, silver.

Castors: 4 swivel castors, rubber tread.

Transport basket TK-R	Order no.
With bumper	05.42710.61-9010

Transport basket TK-D	Order no.
With lid	05.41810.50-0000

01.18 Room-change trolleys RCW

A professional solution for changing rooms

- > *Quick and convenient*
- > *With clothes rail and 2 wire shelves as standard*
- > *Clothes hangers optional*



RCW
Room-change trolley



RCW S
Room-change trolley S

Suspended coat rail

For protecting items during transport: Provides a professional way for guests to change rooms or living quarters quickly and easily.

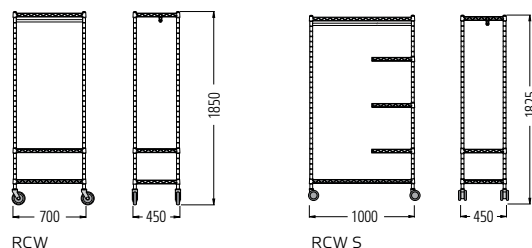

Standard equipment: Uprights with end caps. Plastic clamping bushes for mounting the wire shelves at 50 mm intervals. Wire shelves with plastic powder coating, white.

Finish: High-gloss, chrome-plated uprights, wire shelves and coat rail, half shelves with plastic powder coating, white.

Castors: 4 plastic castors, rubber treads with 2 brakes.

Room change trolley RCW	Order no.
With coat rail and 3 wire shelves	04.30011.10-0000
Accessories	
Clothes hanger made from wire, with high-gloss chrome plating	00.79265.10-0000

Room-change trolley RCW S	Order no.
With coat rail and 2 wire shelves + 3 half shelves	04.09493.95-9010
Accessories	
Clothes hanger made from wire, with high-gloss chrome plating	00.79265.10-0000

01.19 Coat rail GR

A pared-down form with unsurpassed functioning

- > *Can be nested to save space*
- > *Easy to move on castors, brakes optionally available*
- > *With practical hat rack*



GR
Nesting coat rails

GR
Coat rail
Illustration shows optional equipment

Right at the top



Practical hat rack:
Perfect storage, quickly available to hand again.

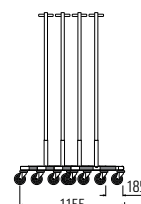
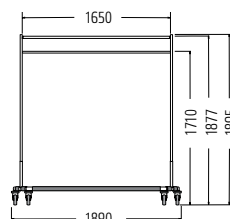

Standard equipment: Attractive steel tubing design with coat rail and practical hat rack. Conical chassis, can be nested to save space.

Finish: Chassis with plastic powder coating in titanium grey, other parts are high-gloss chrome-plated.

Castors: 4 swivel castors with rubber tread, supplied with plastic deflector rings as standard.

Clothes stand GR

With hat rack	04.02713.95-7084
With hat rack and 2 brakes	04.02713.95-0001

Accessories

Clothes hanger made from wire, with high-gloss chrome plating	00.79265.10-0000
---	------------------

Order no.

01.20 Luggage stand KS 600

Somewhere for every item of luggage

> *An indispensable feature of every guest room*

> *Rear bar to prevent slipping*

> *Folding mechanism for space-saving storage*



KS 600
Luggage stand, folded



KS 600
High-gloss, chrome-plated



KS 600
Flash gold-plated

Protects the interior decor in your hotel

The **high bar** and the extension of the rear feet ensure the necessary distance is kept from the wall to avoid damage.

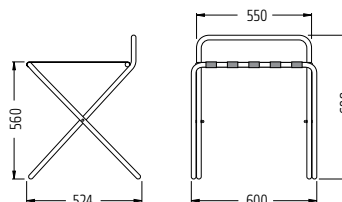

Standard equipment: Easy-to-handle tube frame with bar at back to prevent slipping. Folding mechanism for space-saving storage. Heavy-duty black belts prevent damage to cases.

Finishes: Choice of high-gloss chrome or flash gold-plated.

Luggage stand KS 600	Order no.
KS 600 high-gloss, chrome-plated	04.01922.10-0000
KS 600 flash gold-plated	04.01922.58-0000

02 Product overview

02.01 – 02.05 Luggage collection trolleys



02.06 – 02.08 Luggage transport trolleys



02.09 – 02.10 Guidance systems



02 Front Office



02.01 Premium GS-Trend

The extravagant luggage collection trolley

- > *An eye-catching design for check-in*
- > *Excellent manoeuvrability, optional locking brake*
- > *Integrated coat rail*



GS-TREND

Electro-polished stainless steel
Illustration shows optional equipment.

Design pend.

02.01 Premium GS-Trend

■ **Elegant and stylish first** impression. Innovation and quality packaged in an elegant design: the GS-Trend.



GS-TREND
Electro-polished stainless steel
Illustration shows optional equipment.

Design pend.

Carpet finishes



Optional locking brake

Securely positioned: Even when the GS-Trend is loaded with lots of luggage, the brake holds it in place on uneven flooring.

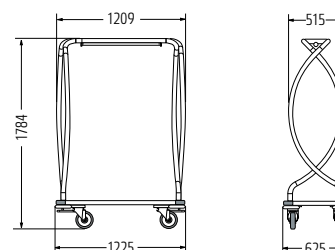

Standard equipment: Round-tube design with clothes rail. Sturdy platform with all-round bumper and deflectors, heavy-duty, stain-resistant carpet in anthracite.
Finish: Electro-polished high-grade steel.
Castors: 2 swivel castors and 2 fixed castors, quiet rubber treads.

Luggage collection trolley GS-Trend

Order no.

Electro-polished stainless steel, carpet in anthracite

05.59778.31-V006

Electro-polished stainless steel, carpet in anthracite, with locking brake

05.59778.31-V007

Logo carpet

On request

02.02 GS-Lobby

The elegant luggage collection trolley

- > Available in high-quality finishes
- > Attractive, heavy-duty carpet lining
- > Optional locking brake



GS-LOBBY
Gold-plated stainless steel

200 kg ↓



GS-LOBBY
Electro-polished stainless steel,
with locking brake

Carpet finishes



*Prevents the trolley
accidentally rolling away*

Optional locking brake
An ideal addition to make the
GS-Lobby secure on inclines.

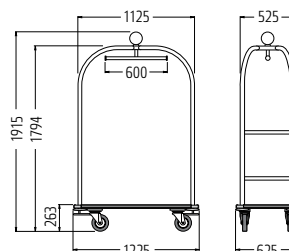

Standard equipment: Tubular design with elegant "crown" and clothes rail.
Sturdy platform with all-round bumper and deflectors, heavy-duty, stain-resistant carpet in anthracite.
Finish: Electro-polished high-grade steel.
Castors: 2 fixed castors and 2 swivel castors, quiet rubber treads.

Luggage collection trolley GS-Lobby	Order no.
Electro-polished stainless steel, carpet in anthracite	05.65428.31-V007
Gold-plated stainless steel, carpet in red	05.65428.58-V005
Electro-polished stainless steel, carpet in anthracite, with locking brake	05.65428.31-V008
Gold-plated stainless steel, carpet in red, with locking brake	05.65428.58-V006
Logo carpet	On request

02.03 GS-Lobby XS

The classic in XS format

- > Available in high-quality finishes – compact design
- > Attractive, heavy-duty carpet lining
- > Optional locking brake



GS-LOBBY XS
Stainless steel, electro-polished



GS-LOBBY XS
Gold-plated stainless steel, with locking brake
Illustration shows optional equipment

Carpet finishes



Prevents the trolley accidentally rolling away

Optional locking brake

An ideal addition to make the GS-Lobby XS secure on inclines.

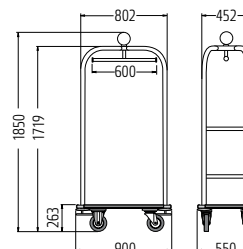

Standard equipment: Tubular design with elegant "crown" and clothes rail.
Sturdy platform with all-round bumper and deflectors, heavy-duty, stain-resistant carpet in anthracite.
Finish: Electro-polished high-grade steel.
Castors: 2 fixed castors and 2 swivel castors, quiet rubber treads.

Luggage collection trolley GS-Lobby	Order no.
Electro-polished stainless steel, carpet in anthracite	04.11301.31-0002
Gold-plated stainless steel, carpet in red	04.11301.58-0001
Electro-polished stainless steel, carpet in anthracite, with locking brake	04.11301-31-0000
Electro-polished stainless steel, carpet in red	04.11301.31-0003
Logo carpet	On request

02.04 GS-Group

The luggage collection trolley for group luggage

- > With generous, stable case storage area
- > Side plastic profiles to protect the interior decor
- > Coat rail provided as standard, can be removed if required

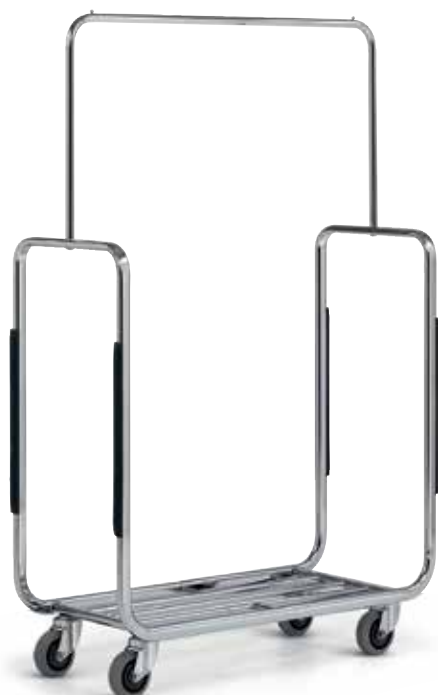

GS-GROUP
Luggage collection trolley



GS-GROUP
Luggage collection trolley, with optional wooden platform

Coat rail as standard

Can be removed if necessary:

A thoroughly practical detail, it can be flexibly adjusted to match the type and amount of luggage.

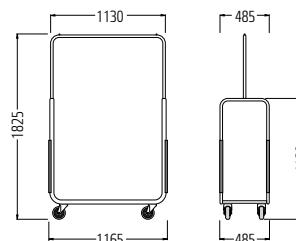

Standard equipment: Round-tube design with robust storage area for cases and bags. Plastic profiles mounted at the side on the upright bars to protect the interior.

Finish: Steel, high-gloss chrome-plated

Castors: 2 swivel castors, 2 fixed castors, with quiet rubber tread.

Luggage collection trolley GS-Group	Order no.
High-gloss chrome-plated	04.02148.10-0000
Accessories	
Wooden platform	77.39221.95-0000

02.05 GS-Compact

The practical luggage collection trolley

- > *Highly ergonomic operation*
- > *Choice of short or long loading area*
- > *Large pneumatic tyres (250 mm) for smooth running*



Stable even when fully laden

As practical as it gets.
Provides lots of space and saves lots of space with its fold-out loading areas in 2 lengths.

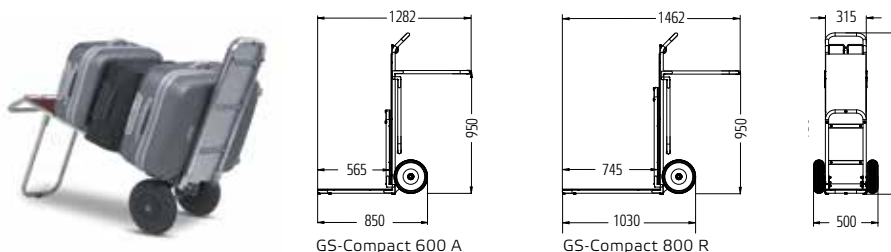

Standard equipment: Round-tube design. Platform can be unfolded for use and folded back up if necessary for space-saving storage. Loading area covered with tough, non-slip carpet.

Finish: Stainless steel, gold-plated stainless steel.

Castors: 2 pneumatic tyres for smooth running, black tread.

Luggage collection trolley GS-Compact	Order no.
GS-Compact 600 R, stainless steel, carpet in red	05.26782.31-V003
GS-Compact 600 A, stainless steel, carpet in anthracite	05.26782.31-V002
GS-Compact 800 R, stainless steel, carpet in red	05.23731.31-V003
GS-Compact 800 A, stainless steel, carpet in anthracite	05.23731.31-V002
GS-Compact 600 R, gold-plated stainless steel, carpet in red	05.26782.58-V001
GS-Compact 800 R, gold-plated stainless steel, carpet in red	05.23731.58-V001

02.06 Aera 300 L

The stylish luggage transport trolley

- > *Impresses with its clear geometry*
- > *Large deflectors protect luggage – the all-round bumper rail protects the interior decor*
- > *Large, high-quality castors ensure easy handling*



AERA 300 L
Luggage transport trolley

Design pend.

Large, protective deflectors

Luggage remains undamaged.
A useful detail that adds to the appeal of the Aera 300 L.

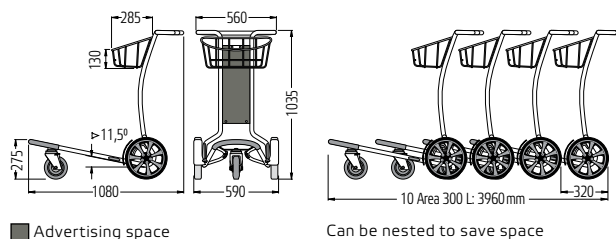

■ Advertising space

Can be nested to save space

Standard equipment: Steel, round-tube design. All-round bumper rail on the large loading area. Generous powder-coated basket. Can be nested to save space.
Finish: Galvanised, chrome-plated, transparent, polyester-coated.

Castors: 2 fixed castors, 1 swivel castor.



Special feature included extra: The handle of the Aera 300 L is treated with an antibacterial coating, ensuring hygienic conditions in the hotel environment.

Luggage transport trolley Aera 300 L

Order no.

Galvanised chrome-plated

05.60795.52-0000

02.07 Voyager 3000

Luggage transport trolley with an impressive design

- > Extremely easy operation thanks to automatic brake bar
- > Antibacterial, ergonomic handle with operating instructions printed on
- > All-round bumper rail protects the interior decor



VOYAGER 3000

Luggage transport trolley

Pat. pend.

Zero-maintenance brake bar

Functionality and safety for your guests in one system.



Pat. pend.

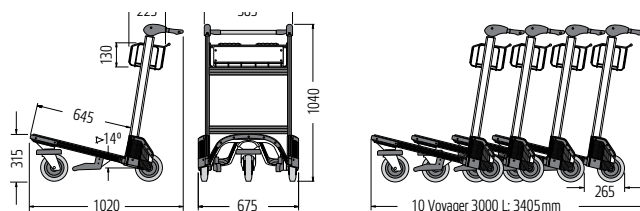

Can be nested to save space

Standard equipment: Aluminium construction
All-round bumper rail on the large loading area. Practical basket for hand luggage or travel paraphernalia. Can be nested to save space.

Finish: Anodised aluminium. Basket in stainless steel, electro-polished.

Castors: 2 fixed castors, 1 swivel castor, rubber treads.



Special feature included extra: The handle of the Voyager 3000 is treated with an antibacterial coating, ensuring hygienic conditions in the hotel environment.

Luggage transport trolley Voyager 3000

Order no.

Anodised aluminium, with brake

05.48251.95-0000

02.08 Travel 300

Luggage transport trolley – simple and convenient

- > *Antibacterial, ergonomic handle with handle caps on the sides*
- > *Can be nested to save space*
- > *Plastic profiles prevent damage to the interior decor*



TRAVEL 300
Luggage transport trolley

Pat. pend.

A stylish space-saver

Wanzl luggage transport trolleys are stylish space-savers for use anywhere. Very versatile and capable of nesting extremely compactly, they allow even large numbers to be used in hotels of all kinds – a benefit that your guests will appreciate too.

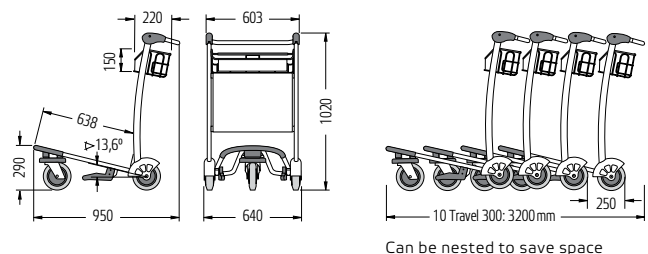

Can be nested to save space

Standard equipment: Steel-tube design with sturdy luggage support. Self-adjusting, zero-maintenance brake. All-round bumper rail on the loading area. Practical basket for hand luggage or travel paraphernalia. Can be nested to save space.

Finish: Galvanised, chrome-plated, transparent, polyester-coated.

Castors: 2 fixed castors, 1 swivel castor, rubber treads.



Special feature included as extra: The handle of the Travel 300 is treated with an antibacterial coating, ensuring hygienic conditions in the hotel environment.

Luggage transport trolley Travel 300

Order no.

Galvanised chrome-plated steel, with brake

05.44296.52-V008

02.09 Part Flex 2000

Flexible guidance system

- > A mobile and effective way to section off areas
- > Uprights made of steel tubing with integrated reel mechanism for pull-out bands
- > Triple docking facility



PART FLEX 2000
Guidance system

Extremely easy to use.

WALL CLIP
Made of stainless steel

Barriers in up to 4 directions

Very flexible and effective guidance system, can be used to separate areas and direct people.



Printed pull-out band

Your hotel logo can be printed according to requirements. Fully in keeping with your universal corporate design.



On request.

Standard equipment: Uprights made from steel tubing with integrated reel mechanism and triple docking facility. Pull-out bands in 3 colours, 2000 mm long. Base plate with slip-proof plastic profile, cover made from black plastic.

Finish: Uprights with high-gloss chrome plating

Dimensions: Upright height 940 mm, base plate ø 340 mm.

Part Flex 2000	Order no.
Upright with pull-out band, red	23.75100.10-0000
Upright with pull-out band, dark blue	23.75101.10-0000
Upright with pull-out band, grey	23.75102.10-0000
Accessories	
Wall clip	23.92892.09-0000

02.10 Part Line 2000

One of the finest examples of guidance systems

- > *Slick elegance for every occasion*
- > *Subtle separation of lobbies, foyers and meeting rooms*
- > *With a practical accessory: poster holder*



MODEL L
In chrome and brass

MODEL C
In chrome and brass













PART LINE 2000
Guidance system

02.10 Part Line 2000 order part



MODEL L

In chrome with poster holder
twisted polypropylene rope in red

Part Line 2000		Supplied unassembled	Order no.	Order no.
Uprights				
Material			Chrome	Brass
		Model L with conical head, height 950 mm, base plate ø 320 mm	04.07122.10-0001	04.07128.06-0000
		Model C with round head, height 1010 mm, base plate ø 320 mm	04.07120.10-0001	04.07127.06-0000
Wall fixing bracket				
		Wall fixing bracket	04.07233.10-0000	04.07233.06-0000
Rope – velvet, 2 m				
End pieces	Rope colour		End piece, chrome	End piece, brass
	 Red		77.38646.00-0001	77.38647.00-0001
	 Black		77.38646.00-0002	77.38647.00-0002
Rope – twisted polypropylene, 2 m				
End pieces	Rope colour		End piece, chrome	End piece, brass
	 Red		77.38645.00-0001	77.38648.00-0001
	 Black		77.38645.00-0002	77.38648.00-0002
Accessories				
Poster holder for uprights (model L)			Chrome	Brass
		DIN A4 portrait	04.07124.00-0000	04.07126.00-0000
		DIN A4 landscape	04.07125.00-0000	04.07131.00-0000

03 Product overview

03.01 – 03.02 Premium minibar filling trolleys



01 MBW SMART



02 MBW SECURE

03.03 – 03.05 Service and serving trolleys



03 ZP UNIQUE



04 RSVC-COMFORT



05 EG 300 + EU 300

03.06 Bottle trolley



06 FW-8

03.07 – 03.08 Tray trolleys



07 TBL 16



08 TBL 20

03 Food + Beverages



03.01 Premium MBW Smart

Minibar filling trolley – with 2 shelves

- > Lockable roll-down panel
- > Insertable shelves with wire bar-railing to prevent slipping
- > With deflectors to protect the interior decor



MBW SMART
Oak finish

Design pend.

03.01 Premium MBW Smart

■ A reliable partner for minibar service

with clearly structured divisions for efficient filling of bottles and small items.

Security as standard

Lockable roll-down panel for all MBW Smart models.



Protective feature

Integrated deflectors made of rubber and all-round bumper profile protect the interior decor of your hotel.



Standard equipment: Steel-tube design, 2 fixed and 2 height-adjustable shelves. Chassis with all-round bumper profile and integrated rubber deflectors. Front side with lockable roller shutter.

Finish: Plastic powder-coated in titanium grey.

Castors MBW Smart-7: 2 swivel castors, 2 fixed castors, with polyamide treads.

MBW Smart-9/Smart-11: 2 swivel castors, 2 fixed castors, with polyamide treads.

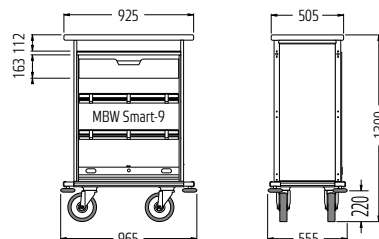

Other sizes for MBW Smart as on fold-out page 13.

Minibar filling trolley models		MBW Smart-7	MBW Smart-9	MBW Smart-11
Dimensions		765 x 527 x 1300	925 x 527 x 1300	1115 x 527 x 1300
		Order no.	Order no.	Order no.
MBW Smart	Anthracite, oak, wenge finish	04.01250.95-V	04.01251.95-V	04.01252.95-V

Optional equipment				
Drawer made from sheet steel, with plastic powder coating, titanium grey		☑	☑	☑
Shelf, shortened, with wire bar to prevent slipping Anthracite, oak, wenge finish		☑	☑	☑
Closable lid Anthracite, oak, wenge finish		☑	☑	☑
Castors with rubber tread		☑	☑	☑
Accessories				
Wooden box for small items, painted pearl light grey		00.21837.78-9022	00.21837.78-9022	00.21837.78-9022
Wooden box for small items, clear varnished		00.60694.78-0000	00.60694.78-0000	00.60694.78-0000
Brochure holder, metal, titanium grey		00.22289.73-7084	00.22289.73-7084	00.22289.73-7084
Top box, metal, plastic powder coating in titanium grey		04.03504.73-7084	04.03504.73-7084	04.03504.73-7084
Spaces for top box on top shelf		1	1	2
Drawer compartment divider		77.76090.73-7084	77.76090.73-7084	77.76090.73-7084

03.02 Premium MBW Secure

Minibar filling trolley – with 3 drawers

- > With lockable plastic roll-down panel as standard
- > Practical compartment dividers for better organisation
- > Upright transportation of bottles of up to 31 cm in height



MBW SECURE
Anthracite finish

Design pend.

03.02 Premium MBW Secure

■ **For reliable minibar service.** Improved design incorporating new drawer division, optimised recessed handles and an effective bumper.



MBW SECURE
Anthracite finish

Upright transportation of bottles

A highlight for the minibar service is the upright transportation of 0.7 litre bottles.



Practical compartment dividers

Helps keep minibar tidy and prevent bottles from falling over during transport.



Standard equipment: Steel-tube design, 3 stable drawers, each with 2 compartment dividers, can be pulled out individually, with built-in lock. Chassis with all-round bumper profile and integrated (non-marking) rubber deflectors. Front side with lockable roll-down panel.

Finish: Plastic powder coating in titanium grey.

MBW Secure-7 castors: 2 swivel castors, 2 fixed castors, with polyamide treads.

MBW Secure 9/11: 2 swivel castors, 2 fixed castors, with polyamide treads.

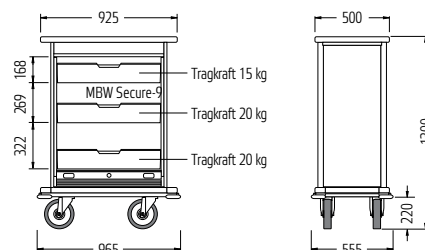

Other sizes for MBW Secure as on fold-out page 13.

Minibar filling trolley models		MBW Secure-7	MBW Secure-9	MBW Secure-11
Dimensions		765 x 527 x 1300	925 x 527 x 1300	1115 x 527 x 1300
		Order no.	Order no.	Order no.
MBW Secure	Anthracite, oak, wenge finish	04.03140.95-V	04.03150.95-V	04.03160.95-V

Optional equipment				
Closable lid	Anthracite, oak, wenge finish	<input checked="" type="checkbox"/>	<input checked="" type="checkbox"/>	<input checked="" type="checkbox"/>
Castors with rubber tread		<input checked="" type="checkbox"/>	<input checked="" type="checkbox"/>	<input checked="" type="checkbox"/>
Accessories				
Wooden box for small items, painted pearl light grey		00.21837.78-9022	00.21837.78-9022	00.21837.78-9022
Wooden box for small items, clear varnished		00.60694.78-0000	00.60694.78-0000	00.60694.78-0000
Brochure holder, metal, titanium grey		00.22289.73-7084	00.22289.73-7084	00.22289.73-7084
Top box, metal, plastic powder coating in titanium grey		04.03504.73-7084	04.03504.73-7084	04.03504.73-7084
Spaces for top box on top shelf		1	1	2
Drawer compartment divider		77.76090.73-7084	77.76090.73-7084	77.76090.73-7084

03.03 Terrace trolley ZP Unique

Specifically for outdoor use

- > Suitable for indoor and outdoor use
- > Low weight thanks to washable fabric cover
- > Large volumes, large load capacity



BRANDING (OPTIONAL)

Your hotel logo according to your requirements.
Fully in keeping with your universal corporate design.



**TERRACE TROLLEY PREMIUM
ZP UNIQUE**

Roll-down panel (optional)

Perfect for transporting
your housekeeping equip-
ment discreetly.

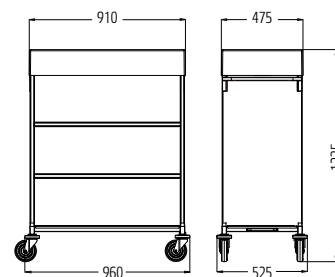

Standard equipment: Solid steel structure, 3 robust metal shelves, 1 deep plastic tray. Water-repellent, washable fabric cover.

Finish: Plastic powder coating in titanium grey.

Castors: 2 swivel castors, 2 fixed castors, rubber tread, castor Ø 125 mm.

ZP Unique	Order no.
Standard equipment 1695 x 525 x 1235 mm	04.07480.95-V
Load capacity: Shelves max. kg each	50
Load capacity: Side parts max. kg each	20
Accessories	Order no.
Roll-down panel in textile fabric, silver-grey	77.18291.95-0001
Branding (logo print)	On request

03.04 RSVC-Comfort

The room-service table

- > With fold-down side parts
- > Can be nested to save space
- > Optional, integrated hot box



RSVC-COMFORT
Room-service table



RSVC-Comfort
With detachable handle



SHELF UNIT
Mobile, for the delivery of a maximum of 6 hot boxes



RSVC-Comfort, collapsed



RSVC-Comfort with hot box

Electric hot box and standard hot box

With 3 shelves, both hot box models are ideal for ensuring meals stay hot on their way to guest rooms.



HOT BOX
Standard

HOT BOX
Electric

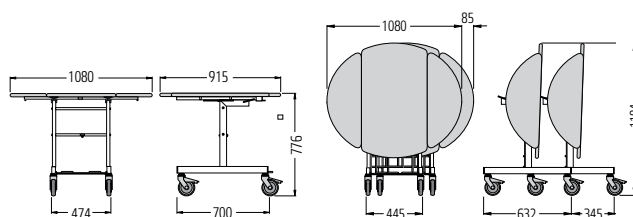

Can be nested to save space

Standard equipment: Steel-tube design with oval table top in wood finish with tough, sealed edge and fold-down side parts. Fold-out chrome-plated rack for the hot box. The table tops can be locked in a vertical position for storage and transport and the RSVC-Comfort can be nested to save space.

Finish: Plastic powder coating in slate grey, RAL 9005.

Castors: 4 swivel castors, incl. 2 with brake, rubber tread.

RSVC-Comfort room-service table	Order no.
With fold-down side parts and one grid shelf	04.11753.95-0000
With fold-down side parts and 2 grid shelves	04.12883.95-0000
Accessories	
Detachable handle	04.12996.73-9005
Dimensions for 1 hot box (mm): W 380 x D 400 x H 510	
Electric hot box, with 3 shelves, hammer-effect silver finish	00.59790.09-0000
Electric hot box, with 3 shelves, hammer-effect black finish	00.59790.09-0001
Standard hot box, with 3 shelves, hammer-effect silver finish	00.59903.09-0000
Shelf unit for 6 hot boxes, mobile	
Dimensions (mm) W 1070 x D 490 x H 1900	04.04634.09-0000

03.05 EG 300 and EU 300

The classic serving trolley

- > With 3 shelves
- > All-round edges for secure transportation
- > Hygienic stainless steel (EG 300)

40 kg
per shelf



EG 300
Serving trolley

40 kg
per shelf



EU 300
Serving trolley

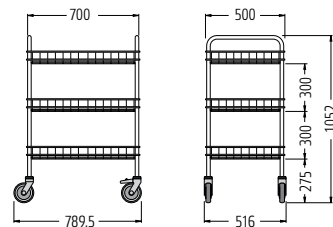
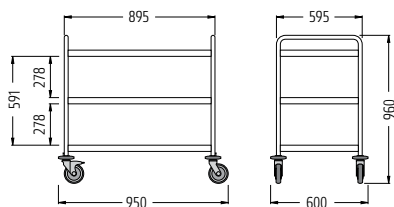

Standard equipment: Round-tube design, available with 2 or 3 shelves.

Finish: Round tubing and shelves made from stainless steel.

Castors: 4 swivel castors with plastic deflector rings, 2 with brake. Rubber tread.

Standard equipment: Round-tube handle.

3 wire shelves with inlaid wooden board bases in birch finish. High edges made from wire.

Finish: Handles and wire shelves high-gloss chrome-plated.

Castors: 4 swivel castors, 2 with brakes, rubber tread.

Serving trolley EG 300	Order no.
EG 300 with 3 shelves	04.04399.09-0000
With optional air-identic castors	04.04398.09-0000

Serving trolley EU 300	Order no.
With 3 shelves	04.02487.10-0000

03.06 FW-8 and FW-16

The mobile, space-saving bottle trolley

- > *Sturdy round tube steel frame*
- > *Storage and transport of 8 or 16 beverages*
- > *With 2 brakes as standard*



FW-8
Bottle trolley

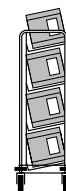

FW-8 - For 8
beverages

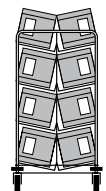

FW-16 - For 16
beverages

Mobile storage

With 2 brakes as standard:

Prevents the trolley rolling away unintentionally, thus securing up to 16 beverages in position.

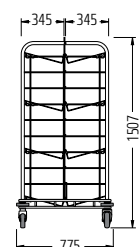
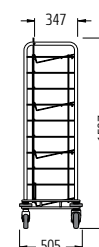
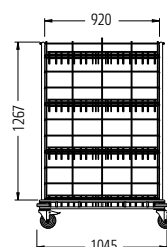

Standard equipment: Round-tube steel frame. Wire mesh shelves, side meshes and chassis.
Finish: High-gloss, galvanised, chrome-plated
Castors: 4 swivel castors with plastic deflector rings, 2 with brake, rubber tread.

Bottle trolley

FW 8 - Single-sided
FW 16 - Double-sided

Order no.

05.84653.50-0000
05.84654.50-0000

03.07 TBL 16

A functional, high-quality tray trolley

- > Holds 16 trays in 2 rows
- > Wood-effect side panels
- > Brake as standard



TBL 16
Tray trolley

Optimum handling

Safely stowed:
Wide wire supports for easy insertion of trays.

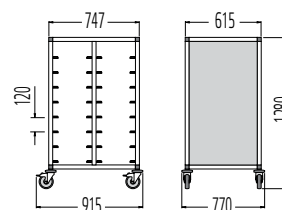

Standard equipment: Round-tube and wire design with side panels in wood finish. Supports made of wire to safely load trays.

Finish: High-gloss chrome-plated.

Castors: 4 swivel castors with deflector rings, 2 with brakes. Rubber tread.

Tray trolley TB 16

For holding up to 16 trays

Plastic tray in light mocha, 530 x 325 mm

Order no.

04.13335.95-0001

04.05086.78-0000

03.08 TBL 20

An elegant, functional tray trolley

- > Holds 20 trays in 2 rows
- > Sturdy panels coated with melamine resin, birch finish
- > Brake as standard



TBL 20
Tray trolley

Indispensable in the catering business

The mobile tray trolley:

For efficient and time-saving service processes. The functional equipment and high-quality finish make the perfect combination.

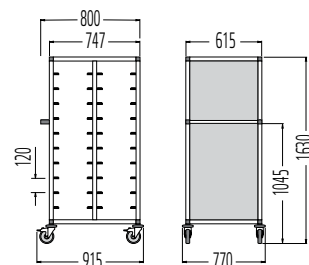

Standard equipment: Frame made of special-purpose anodised light-alloy profiles. 2 separate compartments, enclosed on all sides by melamine resin-coated panels. 10 tray supports on each side, made of high-gloss, chrome-plated wire.

Castors: 4 swivel castors with deflector rings, 2 with brakes, rubber tread.

Tray trolley TBL 20

For holding up to 20 trays

Plastic tray in light mocha, 530 x 325 mm

Order no.

04.13336.95-0001

04.05086.78-0000

04 Product overview

04.01 – 04.02 Service shelves



01 HIGH RACK + HIGH RACK, MOBILE



02 TABLE LINEN TROLLEY

04.03 - 04.05 Transport trolleys



03 MATTRESS TROLLEY



04 T25



05 SP2

04 Storage + Shelving



04.01 High rack

Fixed and movable service shelf

- > Numerous base and expansion elements
- > Shelves also available with plastic powder coating, white
- > Delivery always unassembled – variable installation of the shelves



HIGH RACK
Fixed, corner combination
5 shelves, high-glass chrome
(Example structure)



RACK CONNECTORS
Accessory



HIGH RACK
Mobile, 4 shelves
plastic powder coating, white

HIGH RACK
Fixed, 5 shelves
plastic powder coating, white

04.01 High rack

■ **For even better organisation.** One of the most modern systems for organisation and transport, with numerous different base and expansion elements – fixed and movable – as required.

Variable installation of the shelves

With plastic clamping bushes in the 50 mm grate, the shelves can be flexibly adjusted to the desired height.

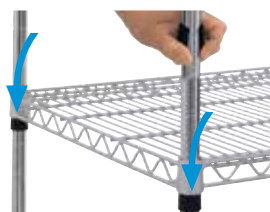

High rack, movable

With high-quality swivel castors, 2 with brakes – guarantee stability and mobility as required.



Standard equipment:

High-gloss, chrome-plated uprights with top end caps and plastic feet or 4 swivel castors, 2 with brakes. Wire shelves in high-gloss chrome-plating or plastic powder coating, white. Plastic clamping bushes for assembling wire shelves with a mesh width of 165 x 20 mm.

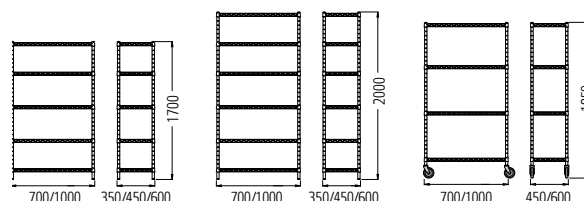

High rack, fixed		Order no.	Order no.	Order no.
	Widths (mm)	Depth 350	Depth 450	Depth 600
Height 1700 with 5 shelves				
Uprights and shelves:	700 mm	04.30000.10-0000	04.30001.10-0000	04.30002.10-0000
High-gloss chrome-plated	1000 mm	04.30003.10-0000	04.30004.10-0000	04.30005.10-0000
Uprights: High-gloss chrome plated	700 mm	04.30000.95-9010	04.30001.95-9010	04.30002.95-9010
Shelves: Plastic powder coating, white	1000 mm	04.30003.95-9010	04.30004.95-9010	04.30005.95-9010
Height 2000 with 6 shelves				
Uprights and shelves:	700 mm	-	04.30006.10-0000	04.30007.10-0000
High-gloss chrome-plated	1000 mm	-	04.30008.10-0000	04.30009.10-0000
Uprights: High-gloss chrome plated	700 mm	-	04.30006.95-9010	04.30007.95-9010
Shelves: Plastic powder coating, white	1000 mm	-	04.30008.95-9010	04.30009.95-9010
Accessories				
Shelf connector		04.30020.00-0000		
High rack, movable		Order no.	Order no.	
	Widths (mm)	Depth 450	Depth 600	
Height 1850 with 4 shelves				
Uprights and shelves:	700 mm	04.03000.10-0000	04.03011.10-0000	
High-gloss chrome-plated	1000 mm	04.02826.10-0000	04.03010.10-0000	
Uprights: High-gloss chrome plated	700 mm	04.03000.95-9010	04.03011.95-9010	
Shelves: Plastic powder coating, white	1000 mm	04.02826.95-9010	04.03010.95-9010	

04.02 Table linen trolley

Time-saving and efficient

- > *Functional equipment*
- > *High-quality finish*
- > *For crease-free table setting*



TABLE LINEN TROLLEY

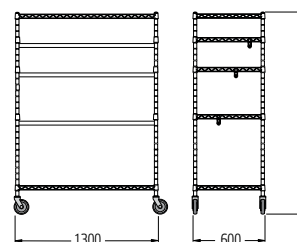

Standard equipment: Uprights with end caps. Plastic clamping bushes for mounting the wire shelves or clothes rails at 50 mm intervals.

Finish: High-gloss chrome uprights White plastic powder-coated clothes rails and wire shelves.

Castors: 4 plastic swivel castors, rubber tread, with 2 brakes.

Order no.	01.10736.95-9010
Width x Depth x Height	1300 x 600 x 1680
Castors Ø (mm)	50
Load capacity: Clothes rail max. kg	50

04.03 Mattress trolley

For transporting particularly bulky items

- > *Mattress trolley: with adjustable guide bars*
- > *Ergonomic, very high load capacity and adjustable*
- > *Wooden platform with non-slip sieve embossing*



MATTRESS TROLLEY
with 3 guide bars

Easy to secure

Bonded-on swivel castors, incl. 2 with brakes, prevent the stand from rolling away unintentionally.

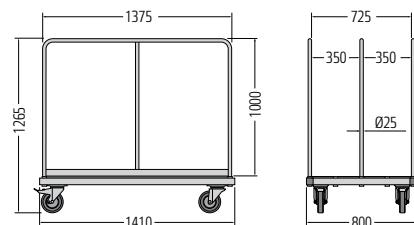

Standard equipment: Chassis made of sturdy square tube frame, adjustable guide rail can be plugged in at 5 heights. Wooden platform with non-slip sieve embossing.

Finish: High-gloss, galvanised, chrome-plated.

Castors: 4 bonded-on swivel castors, including 2 with brake.

Mattress trolley

With 3 guide bars

Order no.

06.41585.50-0000

04.04 Transport trolley T25

Our little helper

- > Can be nested to save space
- > Wire platform with double edging wire
- > With tightly meshed wire basket



T25
Transport trolley

Can be nested to save space

Space requirement in row
Per transporter 300 mm
10 transporters 3770 mm

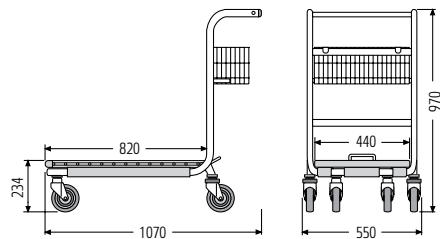

Standard equipment: Can be nested to save space. Rack made of flat rolled steel tubing. Wire platform with double edging wire. With tightly meshed wire basket.
Finish: High-gloss galvanised, chrome-plated and transparent plastic powder coating.
Castors: 4 swivel castors, rubber tread.

Order no.	05.18570.95-V
CastorsØ (mm)	125
Load capacity (kg)	300

04.05 Special transporter SP2

For transporting bulky goods

- > Ergonomically shaped handles
- > For space-saving storage
- > Individual trolley design



SP2
Special transporter with castor
diameter 160 mm

Quiet

Cushion roller and rubber absorber between wooden platform and frame to protect the device and reduce noise.

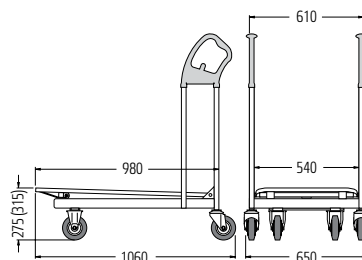

Standard equipment: Frame made of flat rolled steel tubing, round tubing bars with ergonomically shaped handles made of shatterproof plastic. Frost- and water-resistant wooden platform with protective frame all round made of square tube.

Finish: High-gloss, galvanised, chrome-plated.

Castors: 2 fixed castors and 2 swivel castors, rubber tread.

Order no.	Castors Ø 125 mm	Castors Ø 160 mm
Order no.	05.20456.51-V	05.20458.51-V
Load capacity (kg)	400	400

wanzl

HEAD OFFICE GERMANY
Wanzl Metallwarenfabrik GmbH
Rudolf-Wanzl-Straße 4
89340 Leipheim

Phone +49 (0) 82 21 / 7 29-6529
Fax +49 (0) 82 21 / 7 29-6530

hotel-service@wanzl.de
www.wanzl.com